

Product Features



- ◆ Constant voltage output;
- ◆ High power factor >0.96(230Vac& full load);
- ◆ Universal input voltage 90~305Vac;
- ◆ Overall protection: Short circuit / Over temperature / Over voltage / Over load;
- ◆ Surge immunity: line-line 4KV, line-earth 6KV;
- ◆ IP67, glue potted, suitable for dry / wet / damp locations;
- ◆ Ambient temperature:-40℃~60℃.



Application

- ◆ Suitable for landscape lighting.

DESCRIPTION

LSV-050 series is constant voltage led driver, designed for lighting used for landscape illumination. The driver has built-in active PFC, multiple protections, and 6KV surge immunity. it's a excellent design with high reliability and long lifetime. 12V / 24V / 36V / 48V output voltage.

MODELS

Model Number	Max Output Power (W)	Output Voltage Range (Vdc)	Output Current Range (A)	Output Mode	Typical Efficiency	Power Factor	
						115Vac	230Vac
LSV-050B012	50	12	0~4.17	CV	85%	0.99	0.96
LSV-050B024	50	24	0~2.08	CV	88%	0.99	0.96
LSV-050B036	50	36	0~1.39	CV	89%	0.99	0.96
LSV-050B048	50	48	0~1.04	CV	89%	0.99	0.96

Notes:

All performance parameters are measured at 25℃ ambient temperature, 230VAC input, full load conditions, except for those specified

INPUT SPECIFICATIONS

Parameter	Min.	Typ.	Max.	Notes
Input Voltage	90Vac	100-277Vac	305Vac	
Input Frequency	47HZ	50/60	63Hz	
Leakage Current	-	-	0.75mA	277Vac/50Hz
Input AC Current	-	-	0.8A	100-277Vac & full load
Inrush Current(A)	-	-	75A	Cold start, 230Vac & full load
Power Factor	0.95	0.96	-	230Vac;100% load
THD	-	-	15%	230Vac;100% load

OUTPUT SPECIFICATIONS

Parameter	Min.	Typ.	Max.	Notes
Output Current Tolerance	-5%	-	5%	Full load
Output Voltage Ripple	-	-	2%	Full load, Measured by 20 MHz bandwidth oscilloscope and the output paralleled a 0.1uF ceramic capacitor and a 10uF electrolytic capacitor.
Output overshoot	-	-	10%	When the power is on
Line Regulation	-	-	3%	25°C±10°C ambient temperature, 100% load, change input from 90Vac to 305Vac.
Load Regulation	-	-	3%	25°C±10°C ambient temperature, 230Vac input voltage, change load from 50 % to 100 %.
Turn-on Delay Time	-	-	3S	100V-277Vac,100% load.

GENERAL SPECIFICATIONS

Parameter	Min.	Typ.	Max.	Notes	
Efficiency @115Vac Vo=12V Vo=24V Vo=36V Vo=48V	83% 85% 86% 86%	85% 87% 88% 88%		Measured at full load and 25°C ambient temperature	
Efficiency @230Vac Vo=12V Vo=24V Vo=36V Vo=48V	83% 86% 87% 86%	85% 88% 89% 88%		Measured at full load and 25°C ambient temperature	
Efficiency @277Vac Vo=12V Vo=24V Vo=36V Vo=48V	83% 86% 87% 86%	85% 88% 89% 88%		Measured at full load and 25°C ambient temperature	
Dielectric Strength	Input-Output	-	3750Vac	-	10mA/60S
	Input-PE	-	1600Vac	-	
	Output- PE	-	1600Vac	-	
Grounding Resistance	-	-	0.1Ω	25A/60S	
Insulation Resistance	100MΩ	-	-	Input-Output, Input-PE, Output-PE, 500Vdc/60S/25°C/70%RH	
MTBF	-	200000 Hours	-	230Vac,80% load (MIL-HDBK-217F)	
Lifetime	-	50000 Hours	-	230Vac&100%load,70°C case temperature , refer to lifetime VS Tc curve for details	
Operating Case Temperature for Safety Tc_s	-40°C	-	+85°C		
Operating Case Temperature for Warranty Tc_w	-40°C	-	+60°C		
Storage Temperature	-40°C	-	+85°C	Humidity: 20% to 95% RH	
Dimensions (L×W×H)mm	199*42.5*34mm				
Net Weight	510±50g/PCS				
Package	L410*W255*H200mm/15 PCS				

SAFTY STANDARDS

Safety Category	Country / Territory	Standards
CCC	China	GB19510.1, GB19510.14
CE	Europe	EN61347-1, EN61347-2-13
CB	CB Countries	IEC61347-1, IEC61347-2-13
UL	USA	UL 8750
CUL	Canada	CSA C22.2 No.250.13-12
KC	South Korea	K61347-1, K61347-2-13, K62384
PSE	Japan	J61347-1, J61347-2-13
SAA	Australia	AS/NZS IEC 61347-2-13
		AS/NZS 61347.1

EMC COMPLIANCE

EMC Category	Country / Territory	Standards
CCC	China	GB 17743, GB 17625.1
CE	Europe	EN 55015, EN 61000-3-2, EN 61000-3-3
		EN61000-4-2,3,4,5,6,8,11
		EN61547
KC	South Korea	K61547
		K00015
PSE	Japan	J55015
FCC	USA	FCC part 15

NOTE:

This LED driver meets the EMI specifications above, but EMI performance of a luminaire that contains it depends also on the other devices connected to the driver and on the fixture itself.

INRUSH CURRENT WAVEFORM

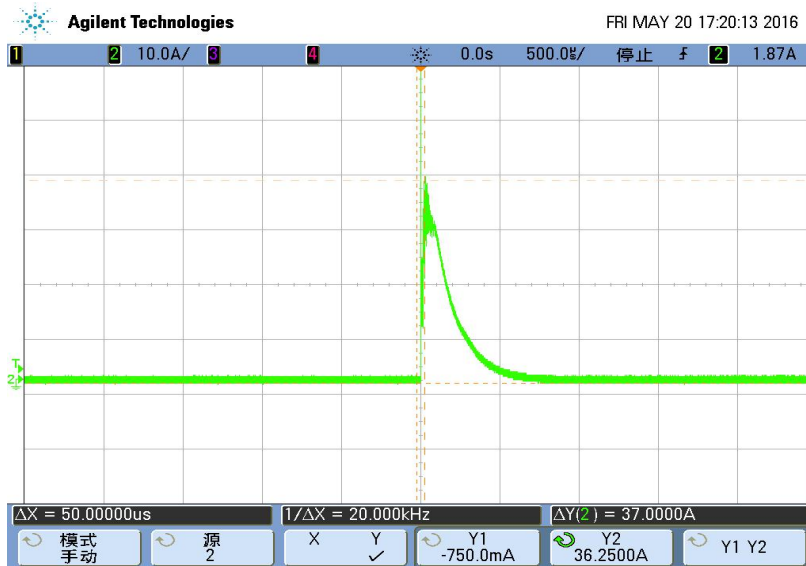

DERATING CURVE

Temperature vs. Load Curve

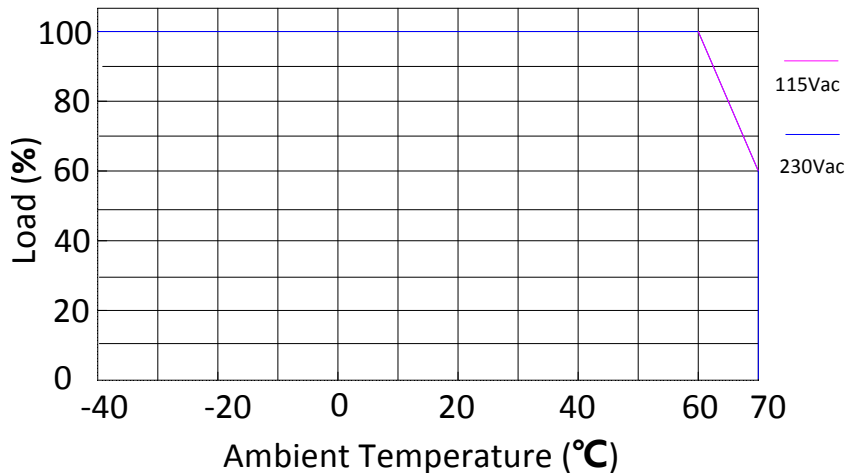

OUTPUT POWER VS INPUT VOLTAGE

Input voltage vs. Load Curve

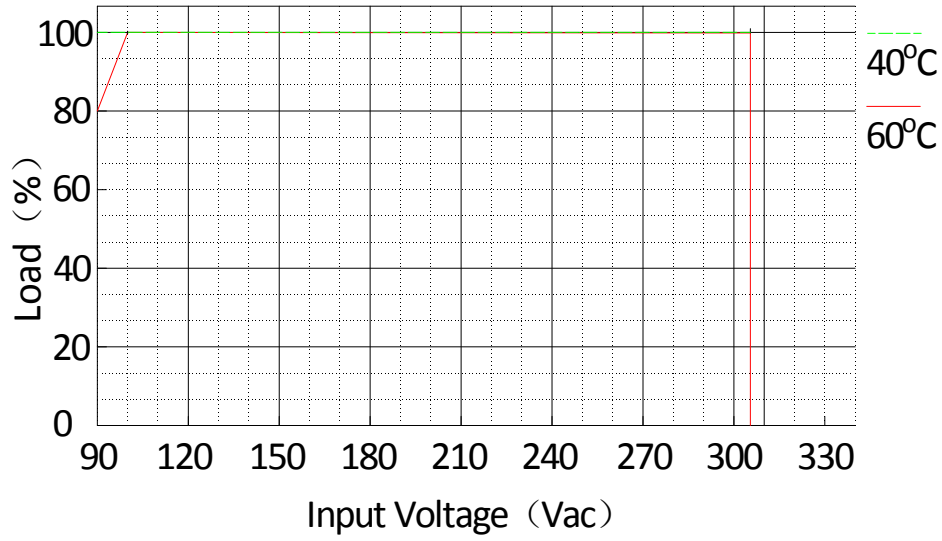

LIFETIME VS CASE TEMPERATURE

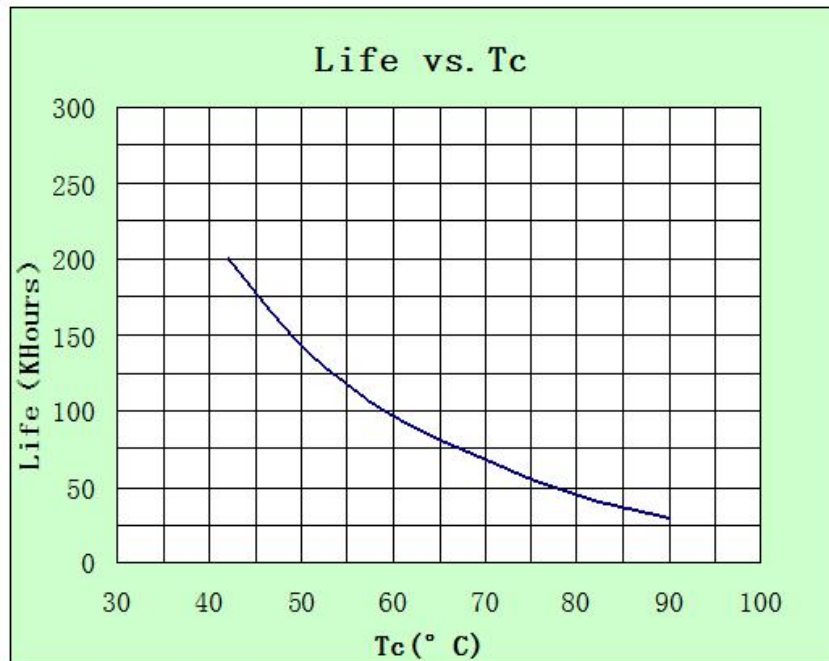

EFFICIENCY VS LOAD

LSV-050B012

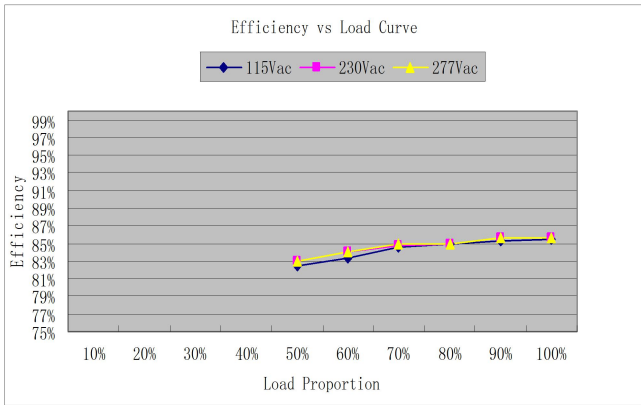

LSV-050B024

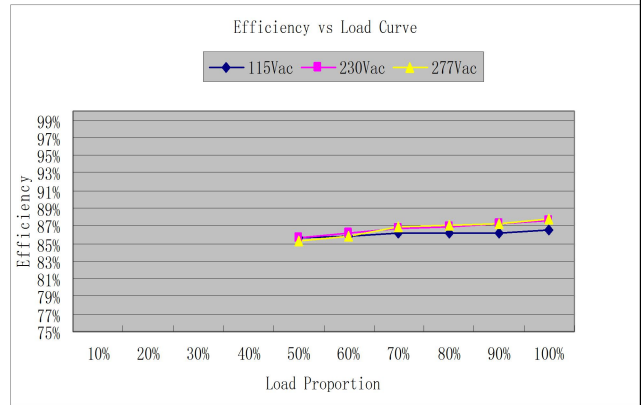

LSV-050B036

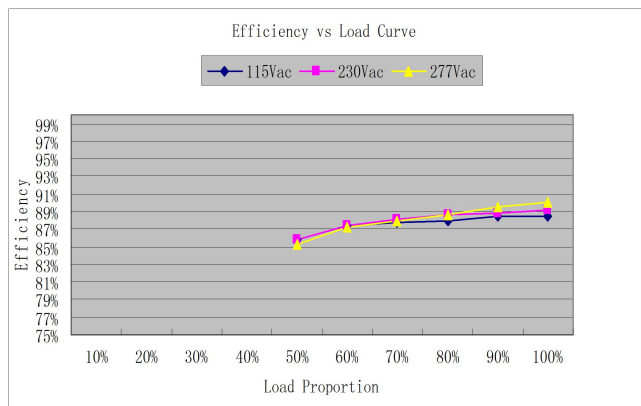

LSV-050B048

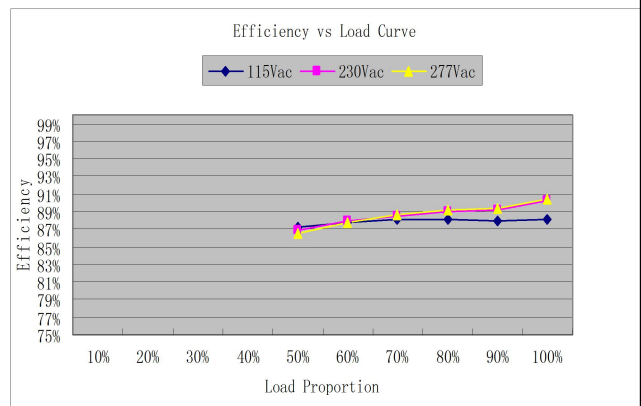

POWER FACTOR VS LOAD

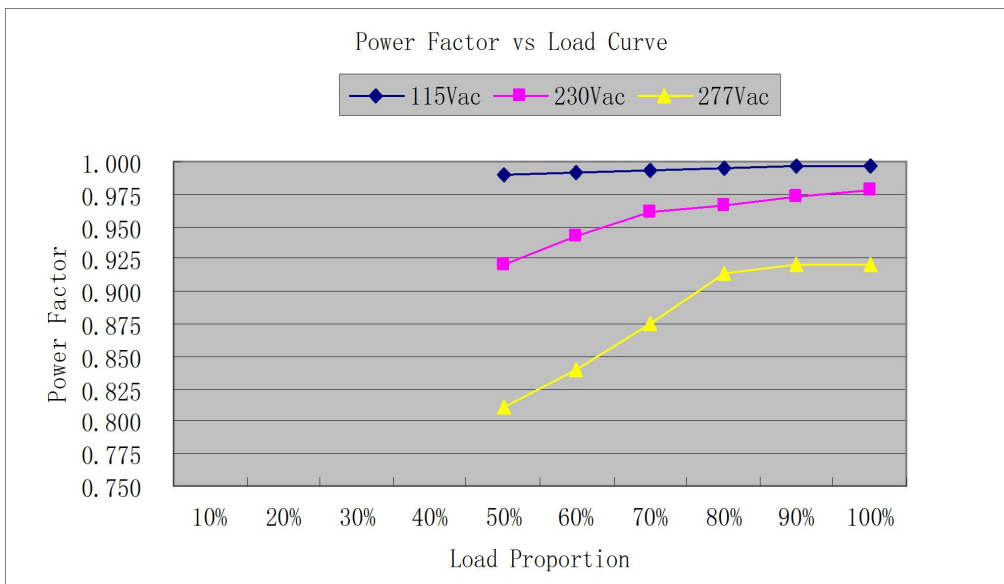

TOTAL HARMONIC DISTORTION

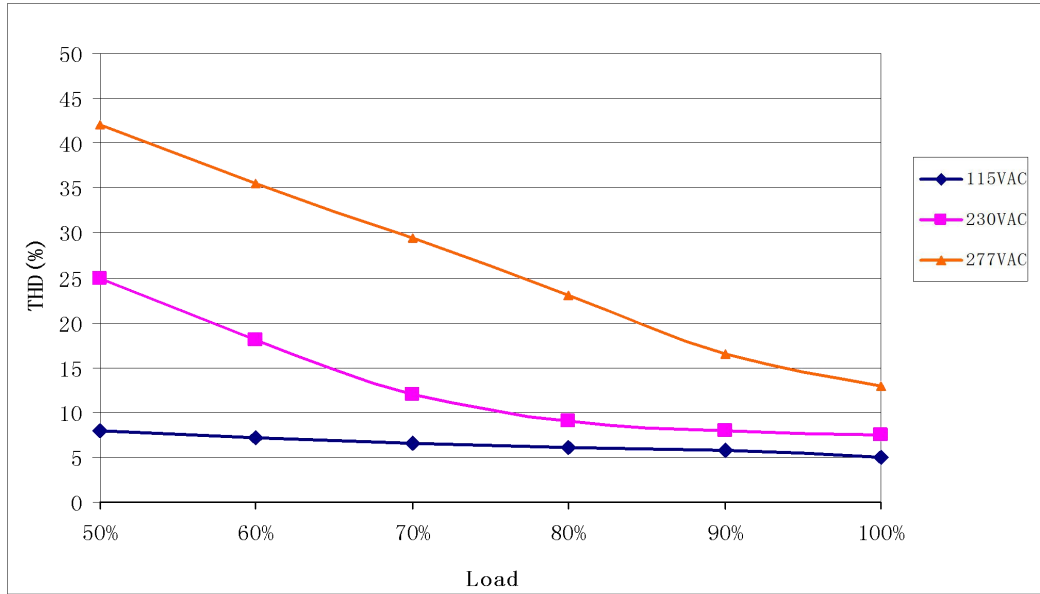

PROTECTIONS

参数	备注
Short Circuit Protection	The output power shall decrease when the output rail short, the power supply shall not be damaged.
Over Current Protection	The product will enter hiccup status when 1.6 maximum load current applied to the output, and the product shall be self-recovery when the fault condition is removed.
Over Voltage Protection	When the output voltage is over 1.1-1.5 Rated Load Voltage, the driver shuts off automatically and enters protection status, the driver will work normally after fault condition removed and AC input reapply.

MECHANICAL OUTLINE

LSV-050 types

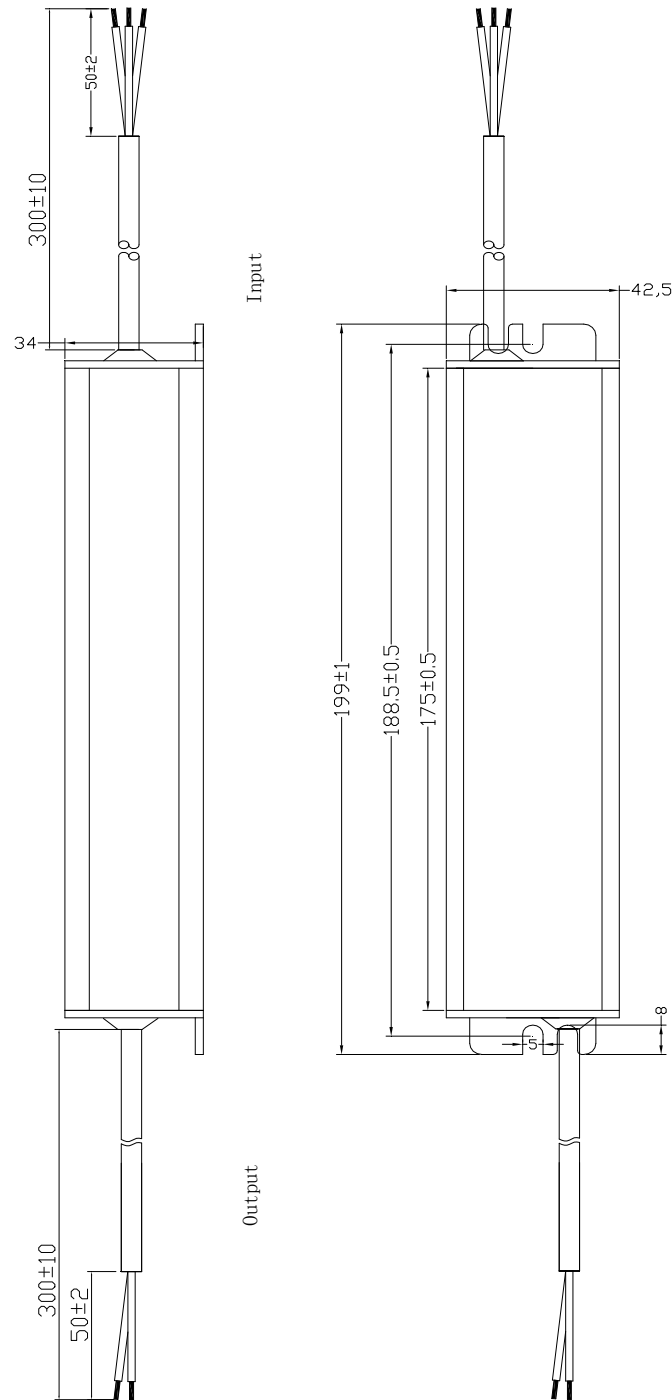

Wire	Specification	Note
AC Input	CCC+VDE 3x1.0mm ² L=300mm	for CE
	18AWG 3C L=300mm	For UL
DC Output	CCC+VDE 2x1.0mm ² L=300mm	for CE
	18AWG 2C L=300mm	For UL

REVISION HISTORY

Version	Description of Change		Date	Notes
	Before	Now		
A.1	—	Datasheets Release	2018-05-11	