

POSC12050A series

12V / 0.5A Wall mounted type AC/DC adaptor



■ Features:

- Universal AC input / Full range
- ErP step II / CEC level VI compliance
- MTBF > 100.000 h

- Protections: Overload / Short circuit / Over Voltage



ELECTRICAL SPECIFICATION

MODEL	POSC12050A
-------	------------

OUTPUT

Rated Voltage	12V
Rated Current	0.5A
Current Range	0 ÷ 0.5A
Rated Power	6W
Line Regulation	± 5%
Load Regulation	± 5%
Tolerance [3]	± 8%
Ripple & Noise (max.) [2]	200mV _{p-p}
Rise Time [4]	100ms / 230VAC at 10% to 90% load
Hold up Time (typ.)	3ms / 230VAC at full load

INPUT

Voltage Range	90 ÷ 264VAC
Frequency Range	47 ÷ 63Hz
Efficiency (typ.)	78.88% - Input115/230Vac / Average (25%+50%+75%+100%) /4
AC Current (typ.)	0.2A / 230VAC
No load Power Consumption (max.)	<0.10W

PROTECTIONS

Overload	0.6A-1.1A Auto-recovery.
Short Circuit	Type: hiccup mode, auto-recovery.
Over Voltage	Type: auto-recovery.

POSC12050A series

12V / 0.5A Wall mounted type AC/DC adaptor



WORKING ENVIRONMENT

Working Temperature	-5°C ÷ 40°C
Working Humidity	5 ÷ 95% RH non-condensing
Storage Temperature and Humidity	-40°C ÷ 85°C, 5 ÷ 90% RH non-condensing

SAFETY and EMC REGULATIONS

Safety Standards	Compliance to EN 62368
Withstand Voltage	IN/OUT: 3.6kVAC
Isolation Resistance	IN/OUT: 50MΩ/500VDC/25°C/70%
EMC Emission	Compliance to EN55032
EMC Immunity	Compliance to EN61000-4-2, -3, -4, -5
Harmonic Current	Compliance to EN61000-3-3; EN61000-3-2

OTHERS

DC wire and plug	Wire: 24AWG*2C, length = 1500mm	Plug: 2.1/5.5mm
Net Weight / Dimensions	60g / 56.0 x 28.0 x 42.0mm (L x W x H)	

MECHANICAL SPECIFICATION



POSC12050A series

12V/0.5A Wall mounted type AC/DC adaptor



MECHANICAL SPECIFICATION: DC wire and plug

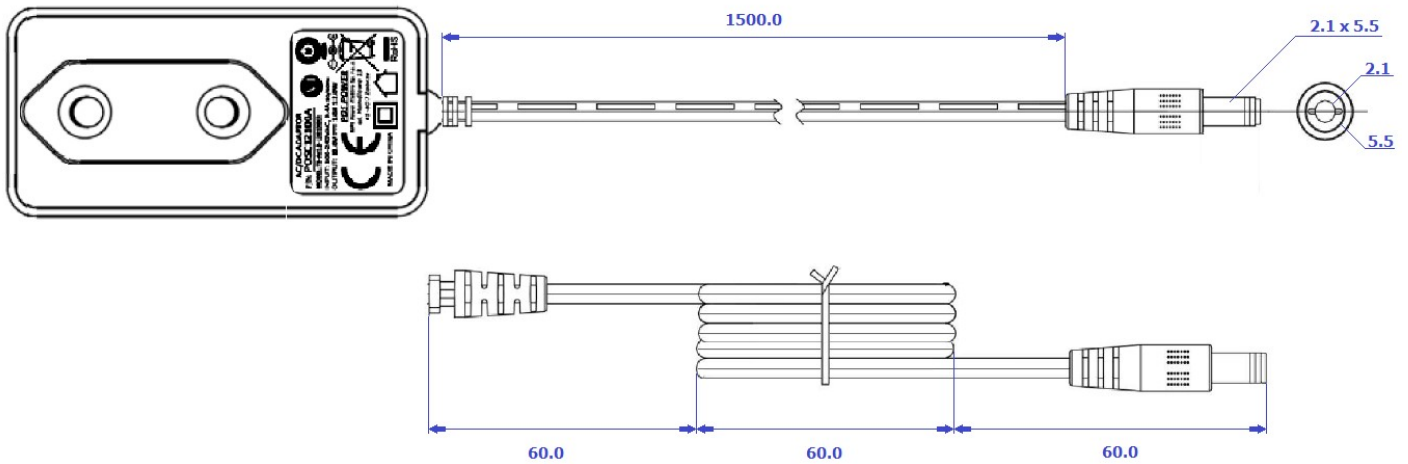

MODEL	DC PLUG	X [mm]	Y [mm]	Polarity
POSC12050A	5.5x2.1	5.5	2.1	Center positive

1. All parameters NOT specially mentioned are measured at 230VAC input, rated load and 25°C of ambient temperature.
2. Ripple & noise are measured at 20MHz of bandwidth by using a 12" twisted pair-wire terminated with a 0.1μF i 47μF parallel capacitor.
3. Tolerance includes set up tolerance, line regulation and load regulation.
4. Setup and rise time is measured from 0 to 90% rated output voltage.
5. Power supply is considered as component not indented to apply by end-user. Power supply meets safety and EMC standards however the final equipment with power supply must be re-quality to comply with EMC Directives.