

# POSC05300A series

5V / 3A Wall mounted type AC/DC adaptor



## ■ Features:

- Universal AC input / Full range
- ErP step II / CEC level VI compliance
- MTBF > 100.000 h

- Protections: Overload / Short circuit / Over Voltage



## ELECTRICAL SPECIFICATION

MODEL	POSC05300A
-------	------------

## OUTPUT

Rated Voltage	5V
Rated Current	3A
Current Range	0 ÷ 3A
Rated Power	15W
Line Regulation	± 5%
Load Regulation	± 5%
Tolerance [3]	± 8%
Ripple & Noise (max.) [2]	200mV <sub>p-p</sub>
Rise Time [4]	100ms / 230VAC at 10% to 90% load
Hold up Time (typ.)	3ms / 230VAC at full load

## INPUT

Voltage Range	90 ÷ 264VAC
Frequency Range	47 ÷ 63Hz
Efficiency (typ.)	81.39% - Input115/230Vac / Average (25%+50%+75%+100%) /4
AC Current (typ.)	0.6A / 230VAC
No load Power Consumption (max.)	<0.10W

## PROTECTIONS

Overload	3.2A-4.5A Auto-recovery.
Short Circuit	Type: hiccup mode, auto-recovery.
Over Voltage	Type: auto-recovery.

# POSC05300A series

5V / 3A Wall mounted type AC/DC adaptor



## WORKING ENVIRONMENT

<b>Working Temperature</b>	-5°C ÷ 40°C
<b>Working Humidity</b>	5 ÷ 95% RH non-condensing
<b>Storage Temperature and Humidity</b>	-40°C ÷ 85°C, 5 ÷ 90% RH non-condensing

## SAFETY and EMC REGULATIONS

<b>Safety Standards</b>	Compliance to EN 62368
<b>Withstand Voltage</b>	IN/OUT: 3.6kVAC
<b>Isolation Resistance</b>	IN/OUT: 50MΩ/500VDC/25°C/70%
<b>EMC Emission</b>	Compliance to EN55032
<b>EMC Immunity</b>	Compliance to EN61000-4-2, -3, -4, -5
<b>Harmonic Current</b>	Compliance to EN61000-3-3; EN61000-3-2

## OTHERS

<b>DC wire and plug</b>	Wire: 18AWG*2C, length = 1500mm	Plug: 2.1/5.5mm
<b>Net Weight / Dimensions</b>	103g / 56.0 x 28.0 x 42.0mm (L x W x H)	

## MECHANICAL SPECIFICATION



# POSC05300A series

5V / 3A Wall mounted type AC/DC adaptor



## MECHANICAL SPECIFICATION: DC wire and plug

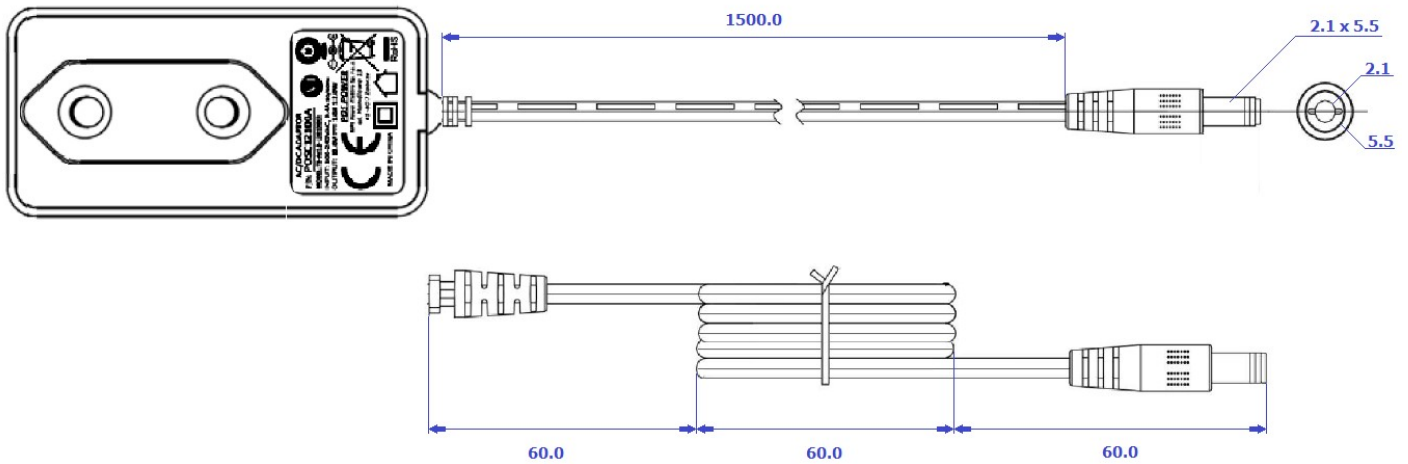

MODEL	DC PLUG	X [mm]	Y [mm]	Polarity
POSC05300A	5.5x2.1	5.5	2.1	Center positive

1. All parameters NOT specially mentioned are measured at 230VAC input, rated load and 25°C of ambient temperature.
2. Ripple & noise are measured at 20MHz of bandwidth by using a 12" twisted pair-wire terminated with a 0.1μF i 47μF parallel capacitor.
3. Tolerance includes set up tolerance, line regulation and load regulation.
4. Setup and rise time is measured from 0 to 90% rated output voltage.
5. Power supply is considered as component not indented to apply by end-user. Power supply meets safety and EMC standards however the final equipment with power supply must be re-quality to comply with EMC Directives.